

Drop-In Drop-in tempered glass top (3 GN container capacity)

ITEM # _____

MODEL # _____

NAME # _____

SIS # _____

AIA # _____

341016 (D04H3)

 Drop-in tempered glass top
 (3 GN container capacity)

Short Form Specification

Item No. _____

Designed to be positioned in flush installation providing improved cleanability and suitable for modern design installations. Designed to serve the food in plates, casseroles, pans. Electronic overheating protection. Digital control with temperature display with precise adjustment (0,1°C). Fully compliant HACCP digital controls include visible alarms. Special design etched foil heating elements to maximize heat transmission on the surface for having the same temperature on the whole surface. Ideal for elegant buffet to display warm food, such as pizza, bun, etc. thanks to the extended surface top. It comes with stylish black coloured tempered heated glass with integrated etched foil elements and stainless steel framed. AISI 304 Stainless steel frame with rounded corners to facilitate cleaning operations. Heating elements connected to the bottom include safety thermostat. Food introduced at the correct temperature maintains its core temperature according to Afnor Standards.

Main Features

- Electronic overheating protection.
- Precise temperature control and setting at 0,1°C .
- As standard the product comes with digitally controlled thermostat which is in line of HACCP norms and provides visual alarm as a warning of the increasing or decreasing temperatures.
- Designed to serve the food in plates, casseroles, pans
- It comes with stylish black coloured tempered heated glass with integrated etched foil elements and stainless steel framed.
- Special design etched foil heating elements to maximize heat transmission on the surface for having the same temperature on the whole surface.
- Ideal for elegant buffet to display warm food, such as pizza, bun, etc. thanks to the extended surface top.
- CB and CE certified by a third party notified body.
- Designed to be positioned in flush installation providing improved cleanability and suitable for modern design installations.
- Available drop-in dimensions: 1, 2, 3, 4, 5, 6 GN.
- Food introduced at the correct temperature maintains its core temperature according to Afnor Standards.

Construction

- Electronic control with temperature display.
- AISI 304 Stainless steel frame with rounded corners to facilitate cleaning operations
- IPx4 water protection.
- Heating elements connected to the bottom include safety thermostat.

APPROVAL: _____

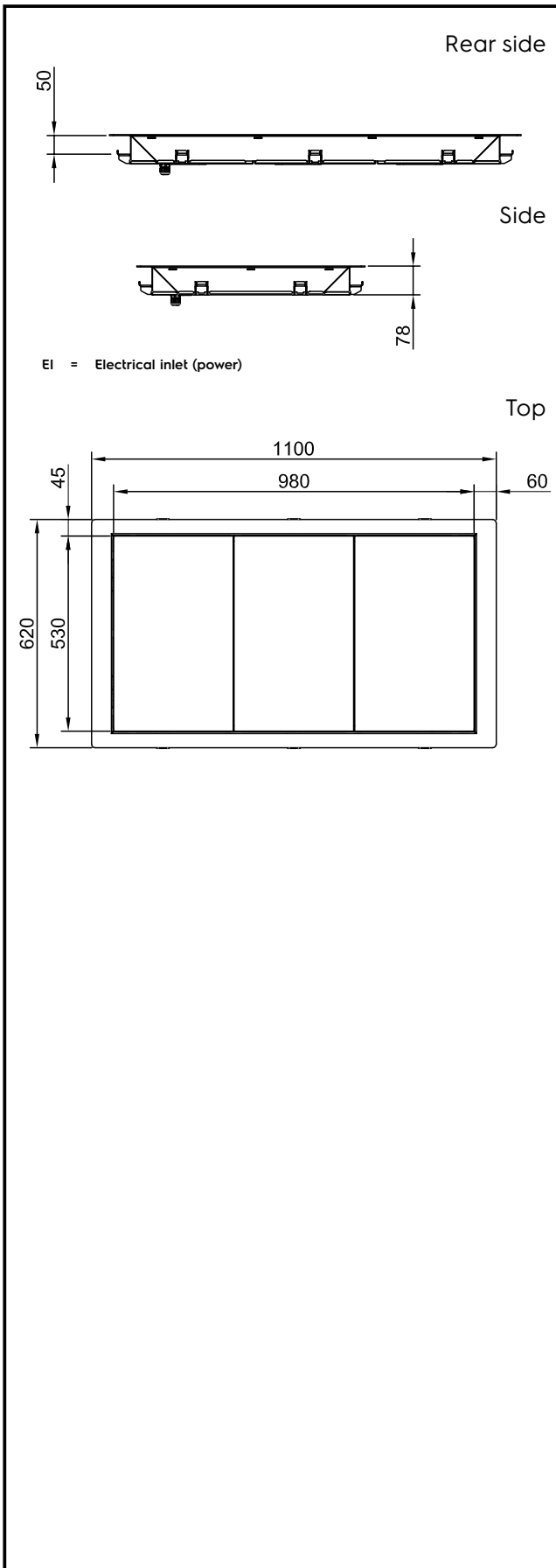

Electric

Supply voltage:

341016 (D04H3)

220-240 V/1N ph/50/60 Hz

Electrical power max.:

0.9 kW

Key Information:

External dimensions, Width: 1100 mm

External dimensions, Depth: 620 mm

External dimensions, Height: 80 mm

Net weight: 20.4 kg

Shipping weight: 42 kg

Shipping height: 200 mm

Shipping width: 660 mm

Shipping depth: 1140 mm

Shipping volume: 0.15 m³

Set temperature: +105 / +115 °C

Sustainability

Noise level:

0 dBA

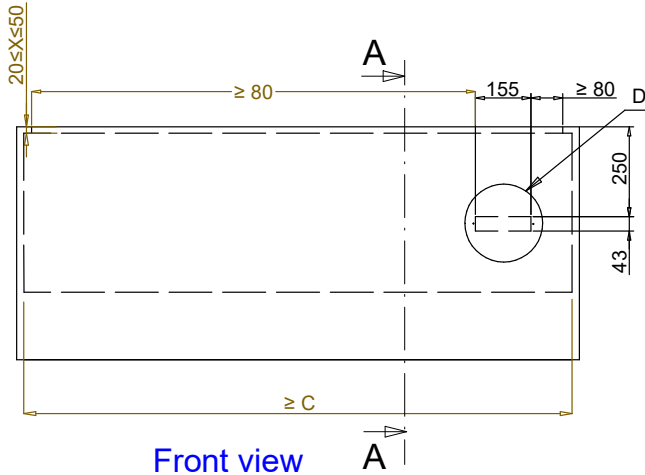

Front view
Scala: 1:10

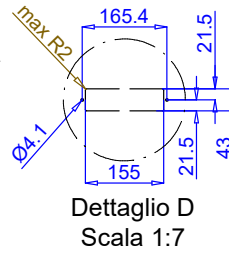

Dettaglio D
Scala 1:7

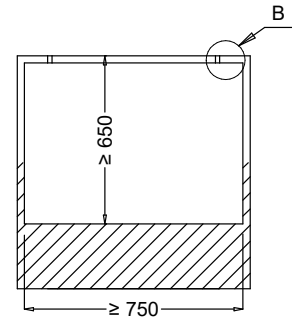

Section Cut A-A
Scala: 1:10

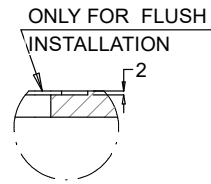

Dettaglio B
Scala 1:2

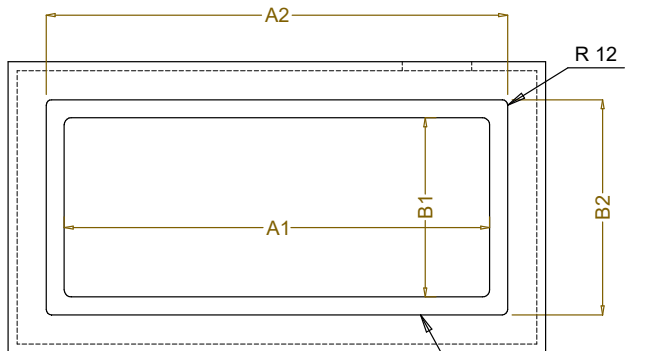

Top view
Scala: 1:10

CAPACITY	CUTOUT		LOWERING FOR FLUSH INSTALLATION		C
	A1	B1	A2	B2	
1GN	355	560	454	624	535
2GN	680		774		855
3GN	1010		1104		1190
4GN	1030		1424		1510
5GN	1660		1744		1835
6GN	1985		2074		2165

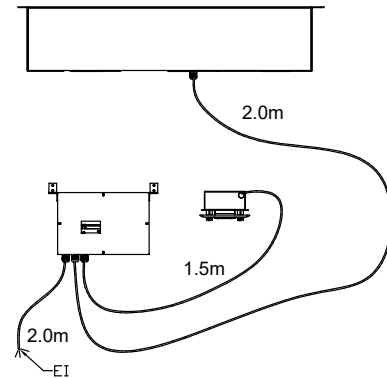
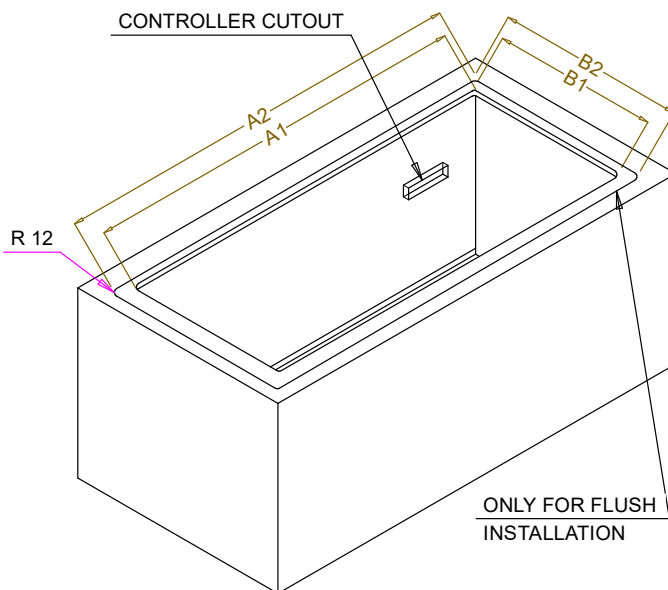

595T01T00 - HOT TEMPERED GLASS